

# 11 THINGS TO KNOW ABOUT MAXPRO<sup>®</sup> INTRUSION

**SAVING YOU TIME & MONEY ON EVERY INSTALL**

**1> It's completely modular**  
Reduction of SKUs with a modular approach



Controller



Cellular



Zone Expander



Relay Board

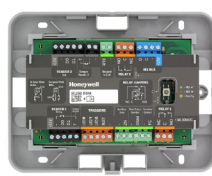

Door Control

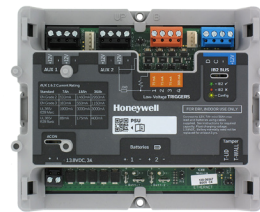

Smart PSU



Peripheral Box

**2> Get on IB2 bus with free star topology**  
Flexible cabling options reduce installation time and cables used

- 4 wires bus
- Free star, daisy chain, spur topology
- Up to 3.6 km distance
- Compatible with standard cables

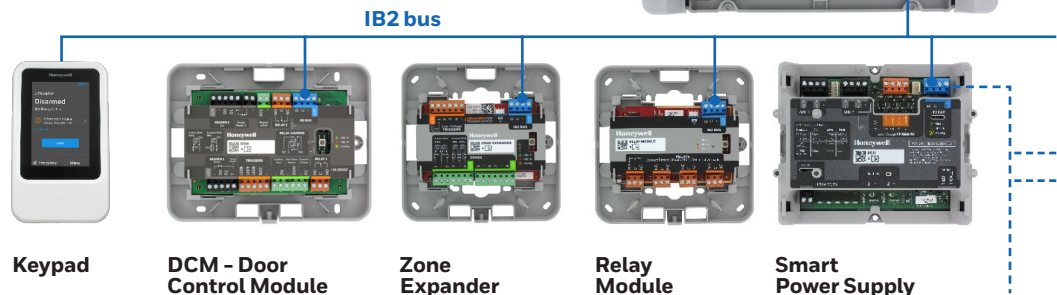
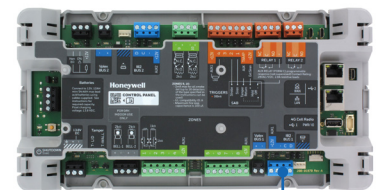

### 3> V-plex bus sensors integrated

#### Bus benefits extended to sensors

- 2 wires bus, very low energy consumption
- Free star, daisy chain, spur topology
- Up to 3.6 km distance
- Compatible with standard cables

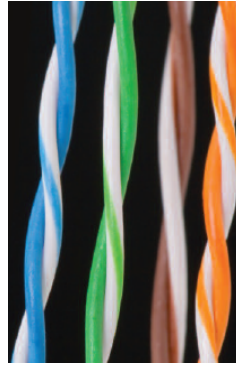

V-Plex sensor

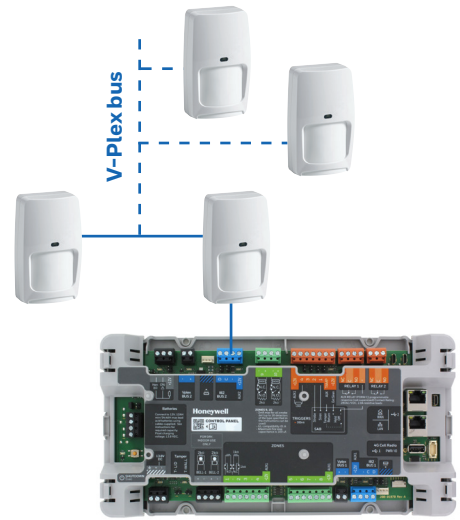

### 4> IP & cloud natively integrated, 4G, IPV6

#### Up-to- date communications, future proof

- 2IP or LTE (4G) connection (dual path)
- Guaranteed service availability 24/7
- Cybersecure



LTE (4G) connection with MAXPRO Cloud as primary or backup path

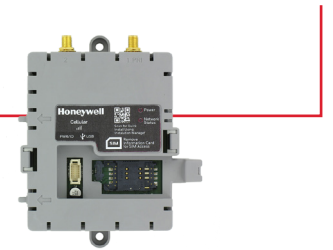
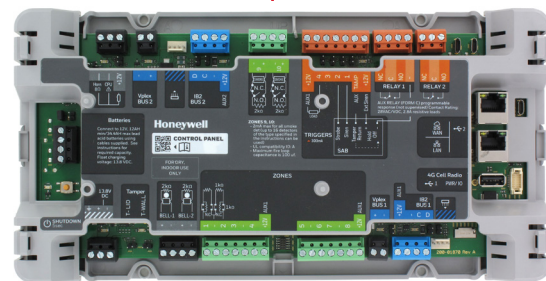

IP port connection with DHCP SSL PKI full end to end secure connection with IPv4 (IPv6 ready, coming soon)

### 5> New Look & feel, color codes & info cards

#### Simplified wiring, less mistakes, looks great

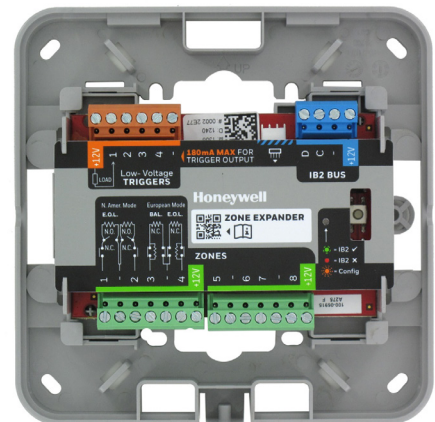
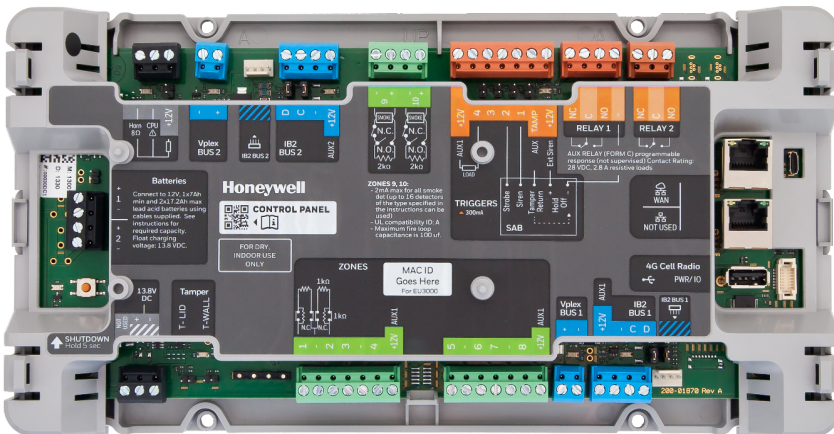

## 6> «plug&play» device approach

Connect and configure reduces install time (and minimises mistakes)

1) Connect to IP one-step with MAC address

2) Scan for devices

3) List of found devices by type enrolled with automatic unique serial number

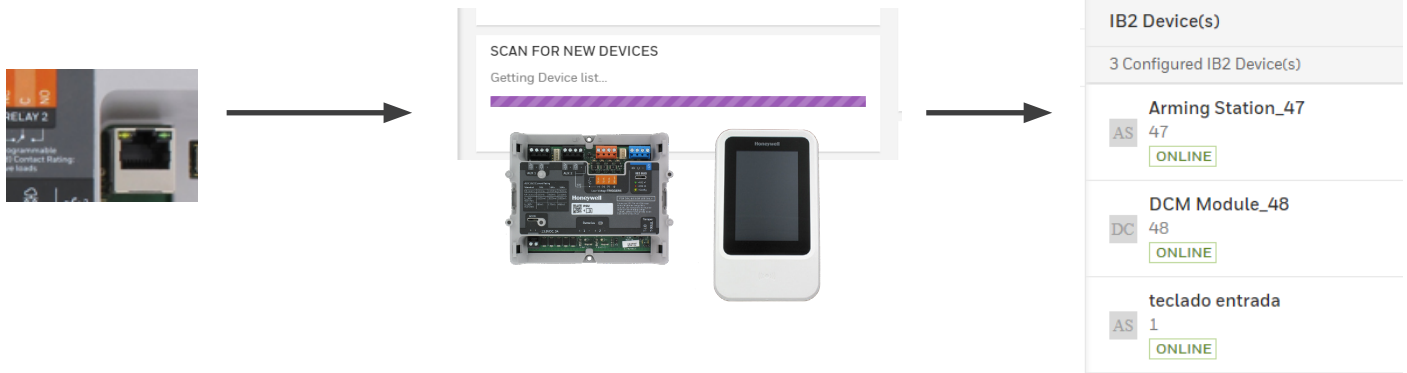

## 7> Simple configuration and maintenance

Fast learning curve, reduces engineer's time and site, visits

Panel I/O

Zones Outputs Diagnostics

0 Unassigned Advanced View

Zone No*	1	Zone Name*	Lab Corner DT
Response Type	3 - Intruder	Area	Lab
Bypassable	<input checked="" type="checkbox"/> Yes	Chime Activation	<input type="checkbox"/> No
Zone Supervision Type	Triple Balanced	EOL Resistor Values	1K
Notes			

### CONTROLLER FIRMWARE VERSION

Current Version: | 3000EU.100.006.20  
Last Updated: | 11/07/2019 02:47:49

[NEW FIRMWARE AVAILABLE](#)

Available Version: | 3000EU.100.006.72

## 8> Diagnostics built-in

Proactive maintenance, saving you truck rolls, time and money

Panel I/O

Zones Outputs **Diagnostics**

Diagnostics data is being streamed from controller

EAGLE-MPIP3000E\_1

Overview Settings Communication Path Alarm Signalling Diagnostics

EAGLE-MPIP3000E\_1

ALARMS

ONLINE

Zone No	Zone Name	Area	Resistance Value (Ω)	
1	Zona 1	Area1-EAGLE-MPIP3000E_1	1.022	
2	Zone 2	Area1-EAGLE-MPIP3000E_1	1.010	
3	Zone 3	Area1-EAGLE-MPIP3000E_1	1.014	
4	Zone 4	Area1-EAGLE-MPIP3000E_1	1.013	
5	Zone 5	Area1-EAGLE-MPIP3000E_1	65.535	
6	Zone 6	Area1-EAGLE-MPIP3000E_1	1.014	
7	Zone 7	Nombre del área_2	1.018	
Normal	8	Zone 8	Nombre del área_2	1.016
Open Circuit	9	Zone 9	Area1-EAGLE-MPIP3000E_1	65.535
Open Circuit	10	Zone 10	Nombre del área_2	65.535

**9> Easy life with intuitive user interfaces**  
**Make users lives easier, improves security and reduces mistakes**



**10> Add door control simply and easily**  
**Integrated door control from one panel**

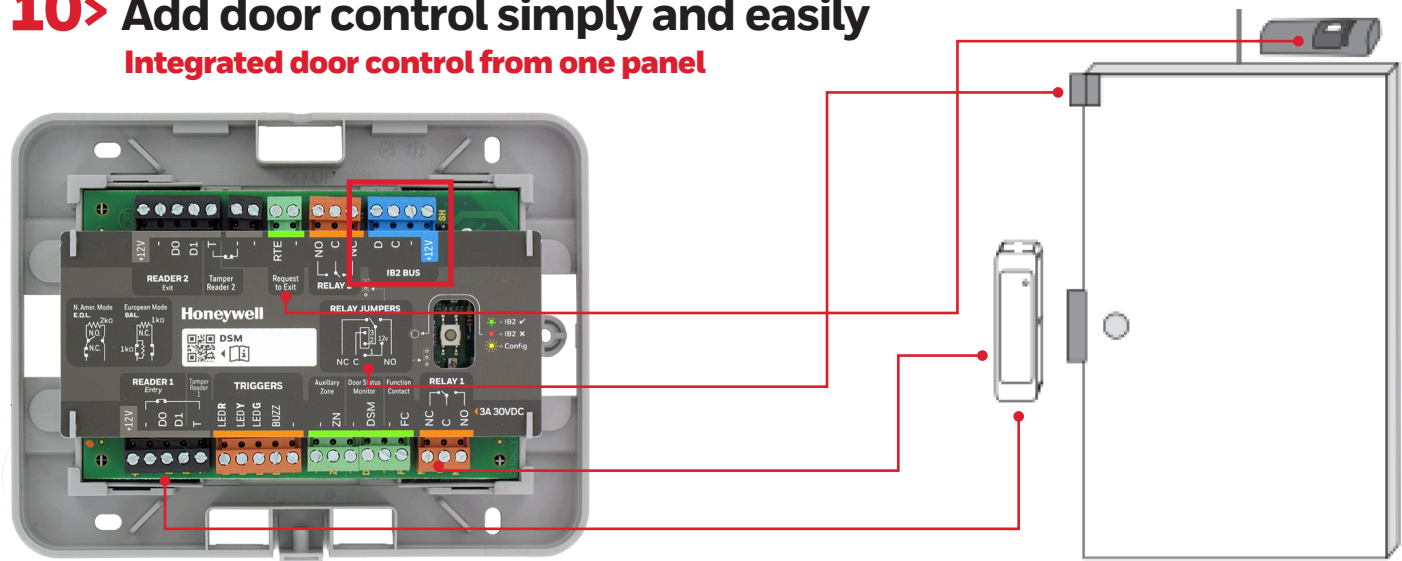

**11> Customise all you want with rules**  
**Tailor security to specific customer's needs easily**

